

Cup with variations
First make the simple one

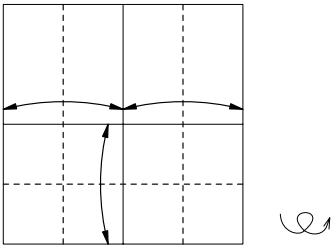

1

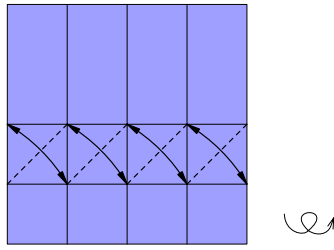

2

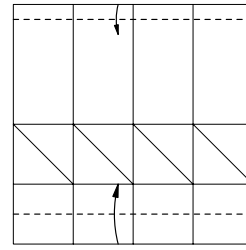

3

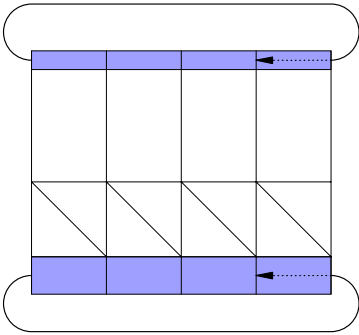

4

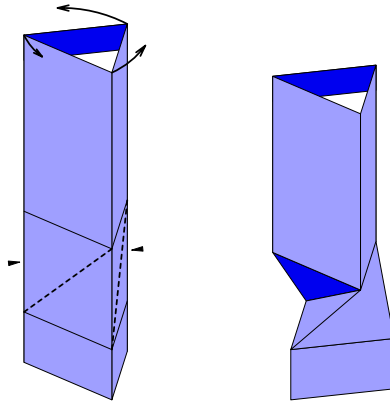

5 Turn/click in position

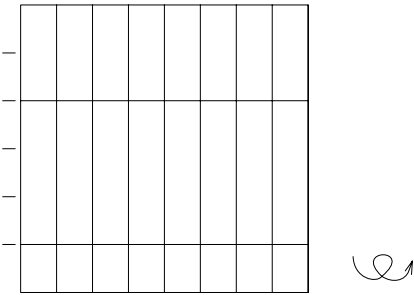

7 Variation 1: divide in 8

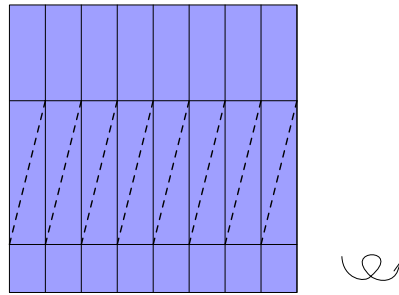

8

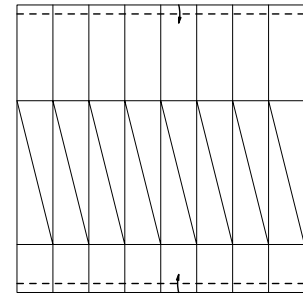

9

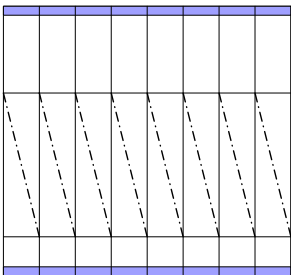

10 Make round and then slide in the overlap

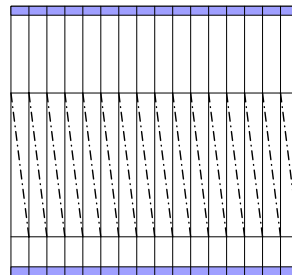

11 Variation 2: divide in 16
Very difficult to form cup!
Variation 3: divide in 32; very, very difficult
And the thicknes of the paper is coming in